

PCM

Tooling (UK) Limited

825 The Ridge
St Leonards-on-sea
East Sussex
TN37 7PX

TEL: 01424 753174
FAX: 01424 753089
www.pcmtooling.co.uk
e-mail: ukpcmtlg@aol.com

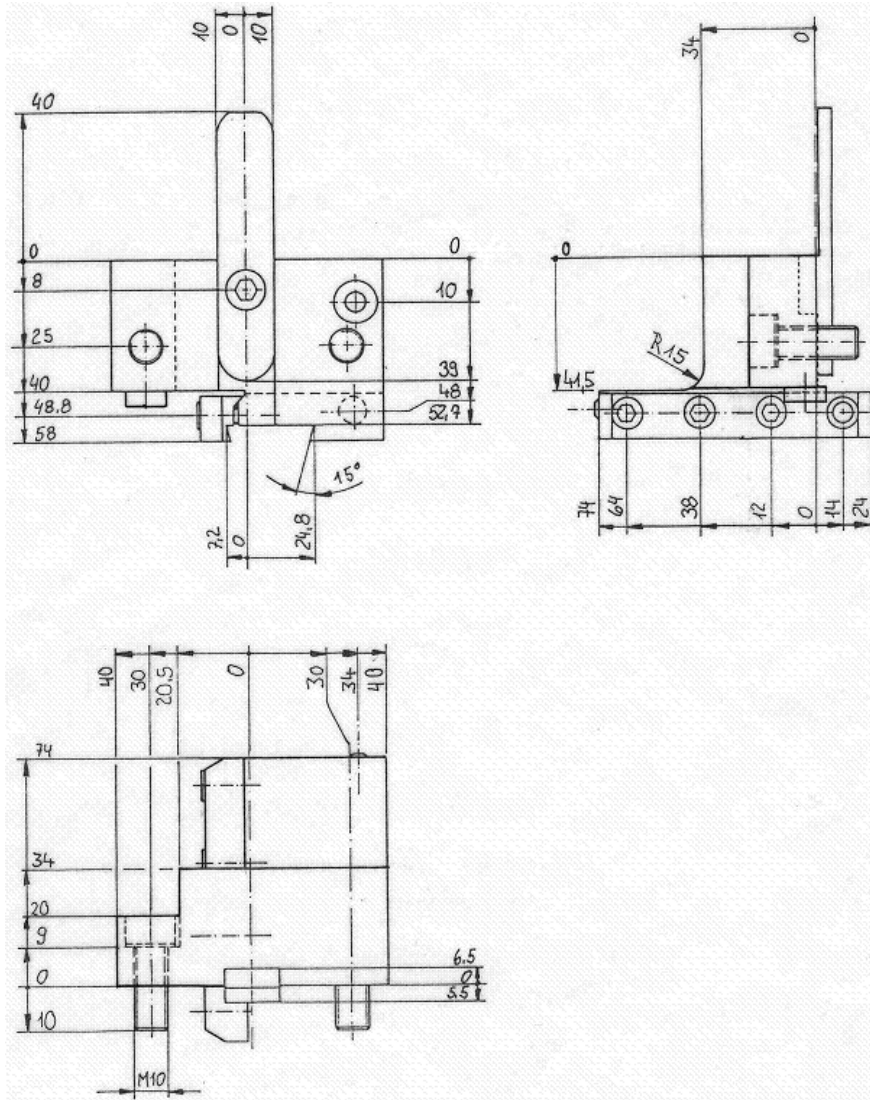

8 224 13 000 Parting Off Holder SH32
Machine Adaption: Centre Pin b20
Tool Adaption: 32 x 5,3
Internal / External Coolant